

# II

## Industries and Open Space In Somerville 1803–1930



McLean Asylum Terrace and Walk with View of North Packing Plant. Photo ca. 1885. This photograph well explains the conflicting land use of the Cobble Hill area. At right is the North Packing Plant complex, which was one of the city's largest and most odiferous slaughterhouses.

### Beauty or Business: Shall We Have Parks or Factories?

This headline from the March 13, 1896 *Somerville Journal* described the late nineteenth century tension between those who wished Somerville to flourish as an industrial center and those who wished to strengthen its character as a residential suburb of Boston. Choices made by town officials about the permissible type and location of industries subsequently influenced the quality and character of Somerville's residential construction. As noted in the previous chapter, Somerville's industrial district was well-established by the Civil War, and the city's unique topography made it difficult to hide the odors and sights of dozens of factories from all but the western Somerville residential districts.

The first half of this chapter analyzes the landscape perceptions of nineteenth century Somerville residents and reviews some of the successes and failures of developers and city officials who attempted to create quality residential developments and public open space. The second half of the chapter describes the variety of Somerville's nineteenth and early twentieth century industries and the land use patterns around the areas in which they were located.

**View of Winter Hill from Central and Hudson Streets, ca. 1869.** In the foreground is the pear orchard of George H. Dickerman. On the hill above Medford Street is the Greek Revival house now at 12 Adams Street, which was moved from Central Street. The round-roofed building at the center of the picture was part of the estate of Phillip Johnson, a florist. The mansard-roofed (second) Forster School, built in 1867 is at right. The 1714 Oliver Tufts House on Sycamore Street is at far right.

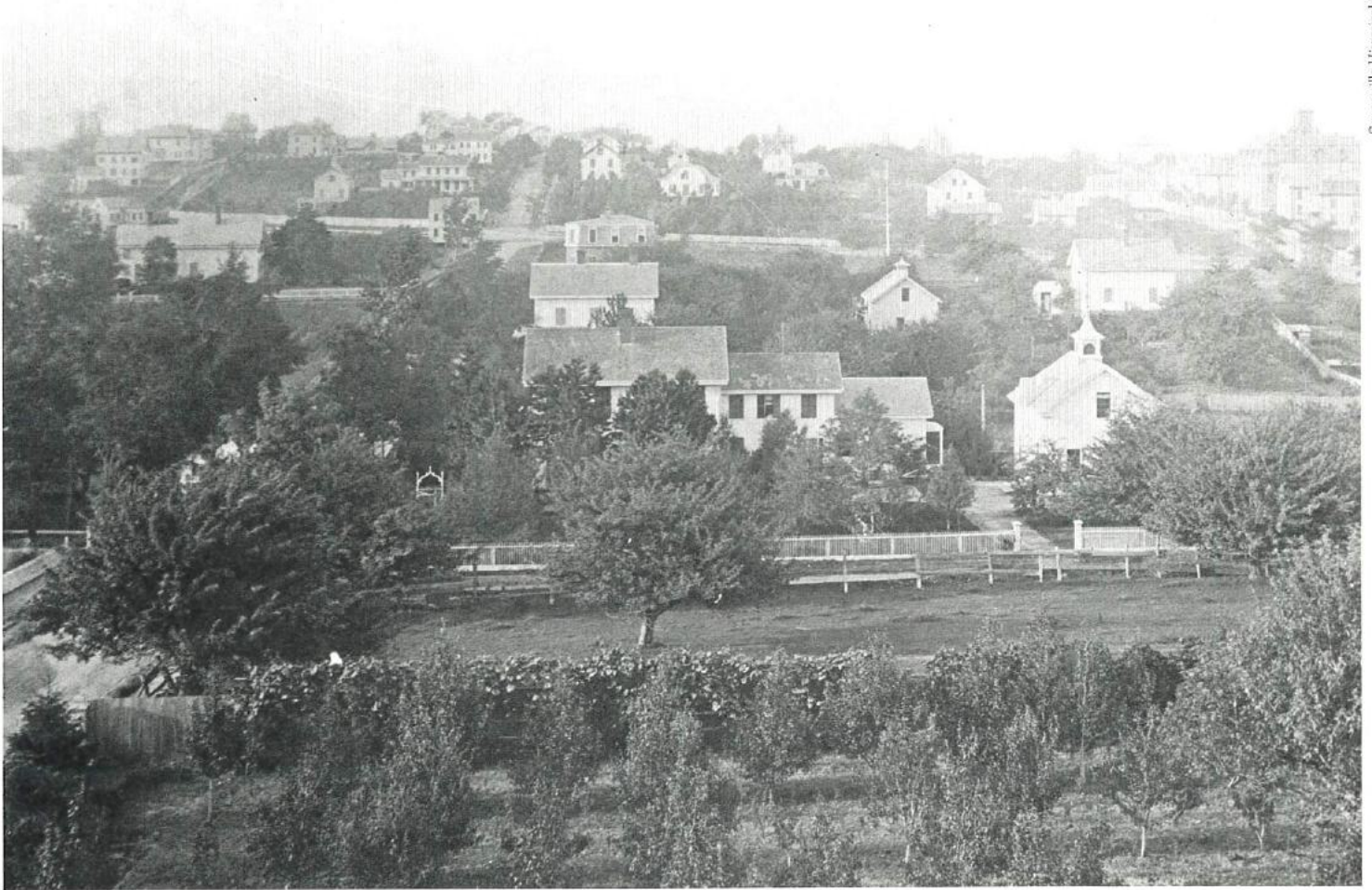

## Space in Somerville

Historically, Somerville's crowded urban environment is the result of a variety of actions and oversights on the part of individual entrepreneurs, private citizens, and town officials. There is no single reason which explains the city's pattern of crowded streets and densely-built neighborhoods, or its lack of large tracts of open space.

Although Somerville reached its greatest density after 1930, with at least 26,365 persons per square mile, most of its available building land was filled by 1900. The houses of the period 1885–1910 were built primarily for a working class population. These houses were built with regard for craftsmanship, but few were allowed more than a sliver of yard space. An abundance of cheap land, efficient public transportation, and what seems to have been a *laissez-faire* attitude of city officials encouraged this character. Large numbers of Somerville's nineteenth century citizens were involved in buying and selling land and building houses; many of the same individuals also held city offices ranging from highway board to mayor.

In 1890, Somerville still possessed large tracts of undeveloped land. The decade between 1890 and 1900 was the critical one in determining the city's spatial future.

While land developers, for marketing reasons, might have wished to create landscaped residence "parks" (with well-sited houses on large lots), as was the practice in portions of nearly every other Middlesex County town, Somerville had not aggressively created a political environment where such develop-

ments could be created. In 1898, the New England Dressed Wool and Meat Company was allowed to begin a large operation near Medford Street, joining several other Ward II firms already engaged in slaughtering. At the same critical time, the city had failed to acquire substantial tracts of land for parks or public open space. Without ordinances to ban offensive industries and without substantial areas set aside for open space, there was little incentive for land developers to create luxurious subdivisions, and the home-seeking public learned to not look to Somerville for such residential amenities. However, with an excellent street railway and passenger rail system and many eager buyers who desired moderately-priced housing, a ready market—accepting of the two family house on its crowded lot—existed.

Offensive industries were confined primarily to Ward II, Asylum Hill, and the Mystic River flats. However, prior to the development of residential subdivisions in west Somerville, much of the land was scarred by extensive brickyards, and it had long been regarded as inferior land, not worthy of beautification. There is no explanation, however, why the handsome Winter Hill estate of spice merchant John R. Poor, with its extensive orchards and sloping site, was turned into a monotonous grid-plan tract of large houses on small lots. On scenic points of Spring Hill, on Westwood Road, and elsewhere in the city, it is difficult to explain why speculators consistently chose not to exploit what nature had left Somerville.



Middlesex Fells Parkway, Somerville portion. Olmsted, Olmsted, and Eliot, Landscape Architects, 1895. Broadway Park served as the beginning of the tree-lined pleasure drive which crossed Medford and Malden en route to the Fells.

## Open Space Planning in Somerville: An Historical Overview

Despite the rapid growth of industries along the shores of the Mystic and Miller's Rivers, and the excavation of large tracts for brick manufacture, Somerville's nineteenth century residents appreciated the landscape beauty of their city. Numerous references praising the views from Somerville's hills and open lands were recorded between 1840 and 1900, echoing the sentiments of Charlestown surveyor Thomas Greaves in 1630. Poems written by local residents, as well as real estate dealers' hyperbolic advertisements, rejoice about Somerville's clean air and views to the surrounding ocean, city and country. As noted in the previous chapter, pollution of the Miller's River in the late 1860s and the razing of Mt. Benedict and Prospect Hill in 1874 were criticized by residents in the local newspapers and the Boston press. The construction of an "inferior class of housing" near factories were protested after the Civil War, and the lack of landscaping in new residential tracts was lamented as early as 1870. In the 1880s, the Somerville Improvement Association was founded as the first of several groups to lobby for trees and open space. Members of social clubs such as the Heptoreans, a Somerville women's organization, regularly devoted their meetings to discussions of improvement which focused primarily on public acquisition of park lands and the development of ordinances to restrict industrial incursion on residential areas.

The hills of Somerville appear to initially have been regarded as the city's most precious feature, but once covered with houses, attention turned to landscape matters such as trees. Characteristically, Somerville's prominent (but not always wealthy) citizens in the period 1842-1900 were "improvers"—Charles Forster and John R. Poor of Winter Hill exemplified the first group of businessmen to campaign for public improvements including parks and open space. As noted in Chapter I, Somerville's town (and later city) government, attempted to keep taxes low and city expenditures to a minimum, and parks were often criticized by land speculators who wished to see all land kept on the private market. Central Park was the only public park constructed during the first thirty years of Somerville's existence as a town. The next, Broadway (Foss) was constructed in 1874 and was bitterly opposed by realtors. Despite controversy, later nineteenth century mayors generally supported public open space acquisitions although only 52 of Somerville's 2400 acres were devoted to parks or playgrounds by 1900 and no extensive tracts were ever successfully secured.

Somerville had a number of concerned citizens who studied the city's open space needs and the recommendations of the Metropolitan Park Commission (later the Metropolitan District Commission) but it lacked a generous private benefactor who might have donated a significant tract to the city, or included park lands as part of one of the 500-lot subdivisions which were created by land developers between 1885 and 1915. Only one tract (Nathan Tufts Park) was donated outright for use as a park; and only one subdivision (in the vicinity of Highland Road) included a landscaped public space or boulevard. In 1889, engineer Dana Perkins included a landscaped circle on several courts or terraces that he designed in 1898 near Beacon Street. The small circle was intended to compensate for the lack of yard space between the closely-sited two-family houses. Carpenter and builder Nathaniel G. Clapp proposed that the city purchase the Ayer Estate, a 60-acre tract between Highland, Willow, Cedar and Broadway and that the city buy the land and "lay it out into about 600 house lots, leaving land for streets, a small water park and one or two squares." The city declined this suggestion, and the area was eventually developed by Wilbur Rice, a Somerville realtor, with few of the suggested improvements.

## Parks and Politics: 1842–1900

When Somerville became a town in 1842, its public open space holdings consisted of a small cemetery on Milk Row (Somerville Avenue), founded in 1803. The Milk Row cemetery was infrequently used after 1842, as the recently-opened Mount Auburn cemetery in Cambridge provided a park-like landscaped setting for burial. Mount Auburn, like a number of picturesque cemeteries in surrounding towns, also became a popular destination for Sunday outings. In the 1860s, Somerville improved its Milk Row cemetery with a cast iron fence and ornamental trees. A Civil War monument was erected in 1863, one of the country's first. Between 1860 and 1900, town officials frequently discussed the need for a new cemetery but no agreeable site was found. One private subscription cemetery was planned for Clarendon Hill, but it failed. While town governments and private syndicates in nearby towns such as Cambridge, Winchester, Arlington, Medford, and Stoneham were setting out large tracts for the construction of landscaped cemeteries with curvilinear walks, rockeries, and fountains, Somerville could not find similar space to serve its growing population.

The period between 1840 and 1900 was important for the development of open space planning in America and in the Boston area. Horticulturists, particularly Andrew Jackson Downing of Newburgh, New York suggested plans for home grounds and cemeteries in popular books and periodicals such as *The Horticulturist* and *The Theory and Practice of Landscape Gardening* (1842). Middlesex County surveyors such as Alexander Wadsworth, John Low, and Amasa Farrier experimented with a variety of park-like residential subdivision plans; Frederick Law Olmsted of Brookline, Massachusetts created New York City's Central Park (1857) and major urban park systems throughout the country. In the last half of the nineteenth century, public parks were acquired by large cities across the country.

In other communities, it was common practice to reclaim marshy areas for park land. Somerville's marshlands and claylands were abundant, particularly along the Mystic and Charles Rivers. By the Civil War, however, the filling of marshes for the construction of railroads and industries such as slaughterhouses was well-underway. The McLean Asylum, atop Cobble Hill, was crowded from its landscaped estate as railyards were built on top of the former marshlands. Ironically, some of Somerville's hills, often promoted for park sites, were also used for fill. By 1870 the Miller River, once a "limpid stream" was a thoroughly polluted corridor; in 1874, Prospect Hill was partially taken down to fill it. Early industrial uses therefore, claimed most of the marshy lands which might have been developed for recreational use. An industrial belt along Somerville Avenue separated Somerville from Cambridge, and the smokestacks and animals awaiting slaughter were highly visible to the residents of Spring, Prospect, and Winter Hills. It is not surprising that the conservation spirit which developed in the 1860s and 1870s and which called for the protection of Somerville's hills sprung from residents of the highlands.

Until the Civil War, with over 2000 yet-undeveloped acres, the early town fathers did not concentrate on the protection of specific sites. Rather, they frequently discussed the merits of cross-city boulevards, particularly one linking Highland Avenue and Charlestown. Several individuals proposed a 100 acre "central park" in the vicinity of Highland Avenue. Although descriptions of this original central park concept evoke visions of a naturalistic "wild" preserve, these discussions resulted in the purchase of 38 acres on Central Hill in 1870. Central Hill Park was laid out between Walnut and School Streets for public grounds and buildings, on the site of Revolutionary War for-

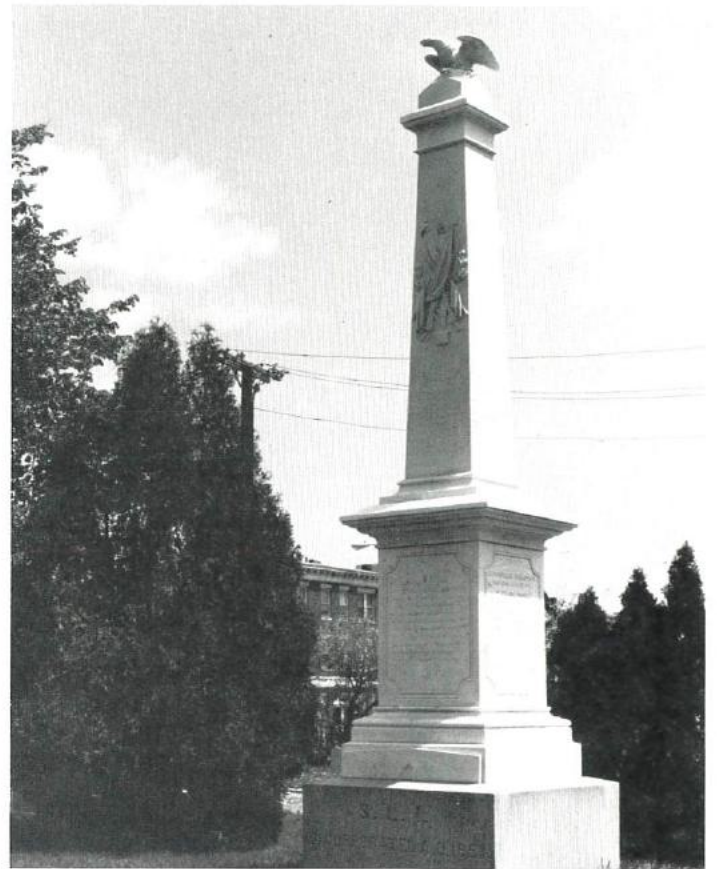

Civil War Monument, 1863. Erected in the Somerville Cemetery by the Somerville Light Infantry.

McLean Asylum, 1884. This atlas plate dramatically illustrates the extent of railroad construction near Cobble Hill.

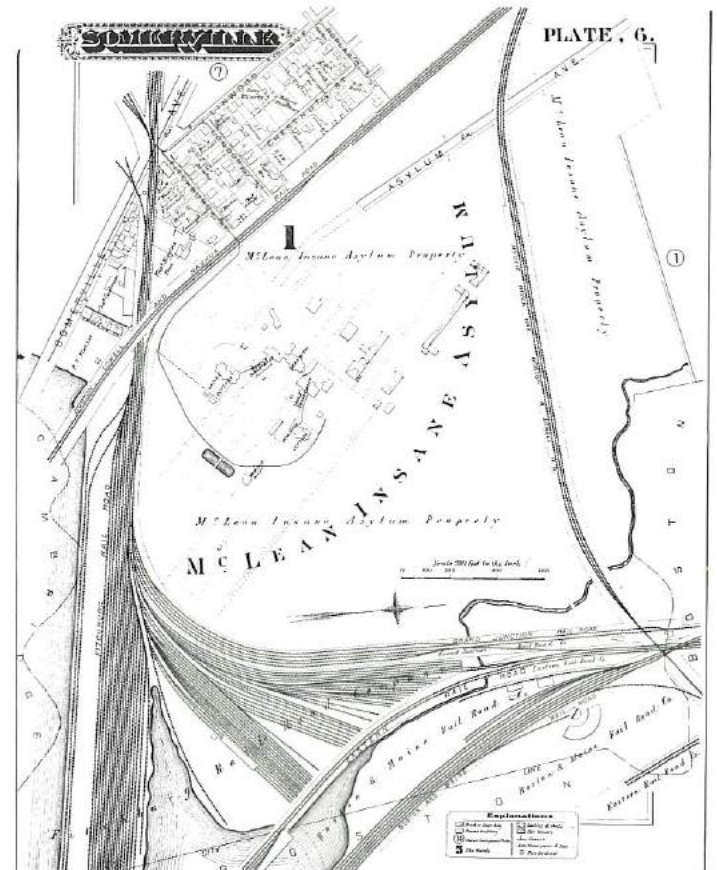



Broadway Park, 1905.

tifications. Between 1870 and 1910, the park was re-landscaped several times and became the site of a succession of public buildings, including City Hall, two libraries, four schools, and an engine house. The original park was formally designed, with symmetrical paths around a central fountain.

In 1870, following a few years of residential and commercial expansion, Broadway Park was proposed by a group of citizens and eventually supported by Mayor George Brastow. Despite controversy over the suitability of the lowland site (crossed by a stream and largely of clay) the design of City Engineer Charles Elliot was built, including a pond and fountains. The bitter controversy over the park—primarily between those who wished to see private real estate interests of the city flourish and those who wished to see public improvement—resulted in George Brastow losing the bid for his re-election.

Tree-planting and street landscaping occupied town fathers in the 1870s and 1880s; most of the impetus came from private citizens. Street-building and improvement, including the construction of sewer lines and drains, was clearly the city's first priority. In 1888, the **Somerville Journal** noted:

... it is a misfortune for Somerville in one way that the growth of the city has been so rapid and that it has not been better directed. Had it been possible to foresee how great the growth of the city would be and to make a general plan by which its growth might be regulated to the best advantage, Somerville today would be a much more attractive city than it is . . .

With "proper attention" the writer noted, Somerville "may yet be made one of the most attractive of Boston's suburbs." Proper attention was directed toward the development of the west Somerville area, which was still largely unbuilt. The Nathan Tufts Park and Powderhouse Boulevard were among the attempts to correct earlier mistakes. In 1890, the heirs of Nathan Tufts deeded the farm and orchard land surrounding the early eighteenth century Powderhouse to the City of Somerville. The park plan, created by City Engineer Horace Eaton, retained the site's outcropping of Medford diabase, and created a focus for subsequent high-quality residential development. Powderhouse Terrace was among the first streets adjacent to the park.

Adjoining the park, Powderhouse Boulevard was first lobbied for in 1895. Twenty years before, in 1874-5, Broadway had been widened, and a series of landscaped islands were created near Broadway Park, but no other significant boulevards yet existed anywhere in the city. Somerville's planned connection to the Middlesex Fells was poor, and the committee which studied the first proposal for Powderhouse Boulevard noted that Somerville "stood along amongst her sister municipalities in her remoteness from the extensive pleasure grounds lying within the Metropolitan Park District." Powderhouse Boulevard was finally built in 1899, connecting to Alewife Brook and Mystic Valley Parkways. A short section of the Fellsway was also constructed at the eastern edge of Broadway Park, linking the Somerville system to the Middlesex Fells.

Despite the financial and political difficulty in securing land in Somerville, town officials acknowledged the need for public open space, particularly to benefit those without access to private recreation. In 1897, endorsing the work of the Metropolitan Park Commission, Mayor Perry stated in his inaugural address:

... it is the wage earners shut up daily in dark stores and dingy work rooms and the children of the poorer classes compelled to live in crowded, ill-ventilated tenements who will derive greatest benefit from the pure air and beautiful scenery of our public reservations and it is our duty to see to it that their needs are not neglected.

The Metropolitan Park Commission was founded in 1892 to create a system of public reservations and boulevards in the Boston Metropolitan area. It was the first of many similar park commissions throughout the country. Despite Somerville's location in a metropolitan area with such a rich tradition of landscape planning, the city struggled to create its first public park and all subsequent parks, playgrounds and boulevards. Somerville's land use practice consumed much of the property which would have been suitable for parks or open space.



Highway Department crew, ca. 1890.

Somerville Historical Society

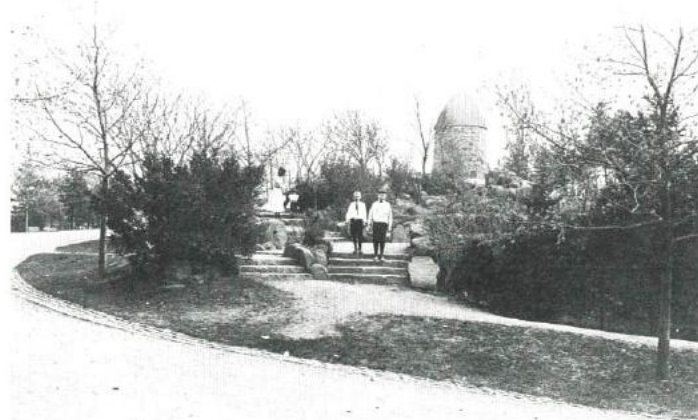

**Nathan Tufts Park, 1892.** Photograph ca. 1898. The farm and quarry land adjoining the Powderhouse was donated to the city in 1890 by Nathan Tufts. The 4½ acre tract included the slate outcropping and irregular terrain of the original landscape. The Powderhouse was conserved, and a new door constructed to replace the original square entrance.

S.P.N.E.A.



Prospect Hill, ca. 1905.

Through the efforts of several social clubs and the Prospect Hill Improvement Society, Prospect Hill Park was built in 1903 according to the plans of City Engineer Ernest Bailey. A section of the original elevation of Prospect Hill was retained, and a crenellated granite monument erected on the summit. Prior to its designation as a park, Prospect Hill was a focus of many of Revolutionary War commemorations, and remains the city's most popular symbolic site.

Playground planning, rather than the planning of landscaped pleasure grounds, occupied the mayor and city officials after the turn of the century. Clay pits, including those on Glen Street and near Washington Street (the former Wyatt Pit) were filled and improved for play areas. Although Bailey, a small scenic park, was set off on Spring Hill (at the site of a 100' standpipe) major tracts were devoted to space for active recreation. Trum Field was the major acquisition of mayor Edward Gline's administration (1901-03).

The shores of the Mystic, once the site of brickyards, bottling works, and wharves, were also singled out for protection. Shore Drive was constructed in 1900 and a portion of the shoreline deeded to the Metropolitan Park Commission. The preservation of the shoreline was part of an attempt to improve the sanitary as well as the aesthetic character of the river. In defending the taking of shore land, the city cited the "nature of the land," since "offensive establishments and cheap dwellings would get a foothold on the banks unless land was taken." In 1911, after the straightening of Alewife Brook by the Metropolitan Park Commission, the city acquired a playing field near Broadway at the Arlington border, now known as Dilboy Field.

Bikeways also concerned park planners in the 1890s. In 1897, Mayor Perry noted that the use of the bicycle was becoming more popular. He proposed the paving of gutters adjacent to roadways with asphalt, particularly along popular bicycle routes such as Highland Avenue. Somerville's major parks and boulevards were conceived in the pre-automobile era, and surfaces and bridges were altered or re-engineered after the introduction of automobile traffic.

Field Day at Trum Field, 1917.

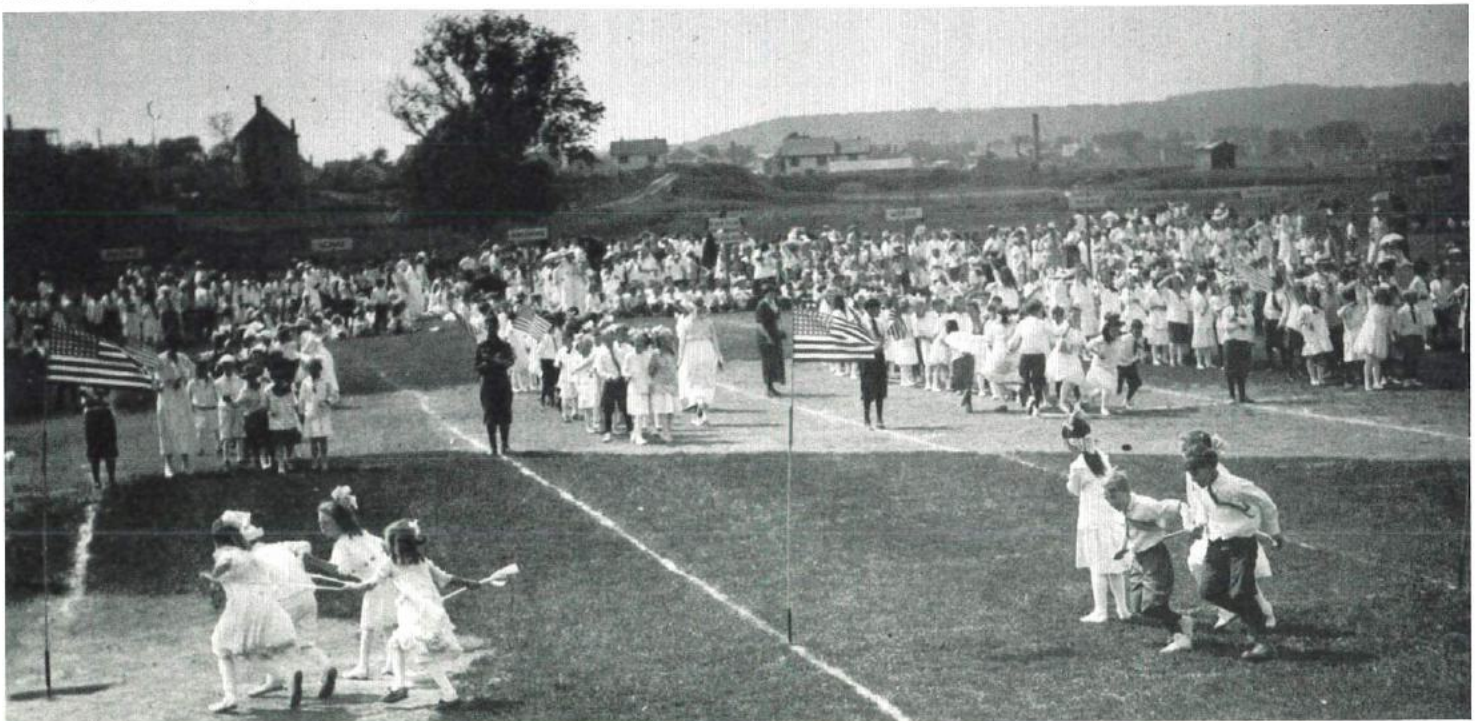

## Landscape Design at Home: Nineteenth Century Somerville

Joseph Barrell's 1793 estate at Cobble Hill included acres of carefully-landscaped grounds. Much of Barrell's estate was devoted to the display of costly horticultural specimens imported from Europe. Although no Somerville estate ever rivaled Barrell's in size or complexity of planting, ornamental landscaping occupied many nineteenth century residents. Nineteenth century yards, or "home-grounds" as they were called, were often planted with small orchards as well as exotic trees and rare specimens of shrubs and flowers. Home-owners of both wealth and average income were assisted by a collection of gardening and landscaping books, including those by experts Andrew Jackson Downing and R. Morris Copeland. Ornamental fences, rockeries, small pools, (and hot houses, in a few instances,) were set along curving paths. Copeland's popular book, *Country Life* (Boston, 1863), provided city dwellers with information in yearly calendar form, ranging from grafting tubers of the tree peony to laying out the grounds.

In the era before air-conditioning, arbors, gazebos, and porches were also a part of the outdoor landscape. An 1868 photograph of the grounds of Central Street resident George Dickerman shows his pear orchard at the rear of the property, with a Gothic-style arbor placed prominently at the front.

Garden clubs, women's clubs, and Somerville's city improvement societies which sprung up in the 1880s and 1890s advocated home landscaping, despite the small lots which surrounded the majority of the city's homes. A number of Somerville residents were members of the Massachusetts Horticultural Society, particularly those who raised fruit.

Detecting remnants of nineteenth century landscape design is often difficult because of the modern incursion of asphalt driveways and chain-link fences. Maps and old photographs are a good source of information about the former appearance of home grounds. Curvilinear paths and carriage roads which once encircled flower beds have usually been straightened and paved, and many of the larger grounds have been subdivided and built over. Today, evidence of the original landscaping is found primarily in retaining walls of Quincy Granite or Somerville Slate, or in fence materials of cast iron or fieldstone. Many fences of smaller-size stones set in mortar were built by Italian immigrants after the turn of the century.

**Granite posts, Columbus Avenue, ca. 1870.** Fashionable houses on Prospect Hill had extensive retaining walls, edgestones, and posts of Quincy granite. In some cases, ornamental ironwork was also used as fencing.

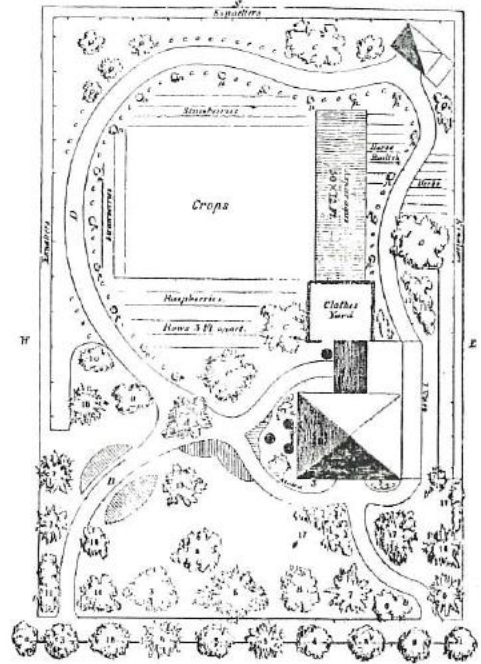
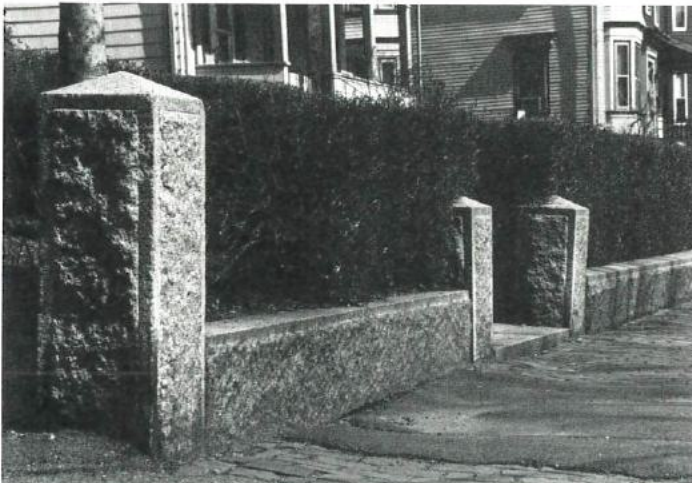

**Village Garden, from R. Morris Copeland's *Country Life*.** Copeland, a landscape designer, recommended this garden for either "a man of wealth, or one who lives by daily labor." It could be adapted to any size lot.



**Prospect Street garden, 1982.**

**Cast-iron fence, Central Street, ca. 1870.**

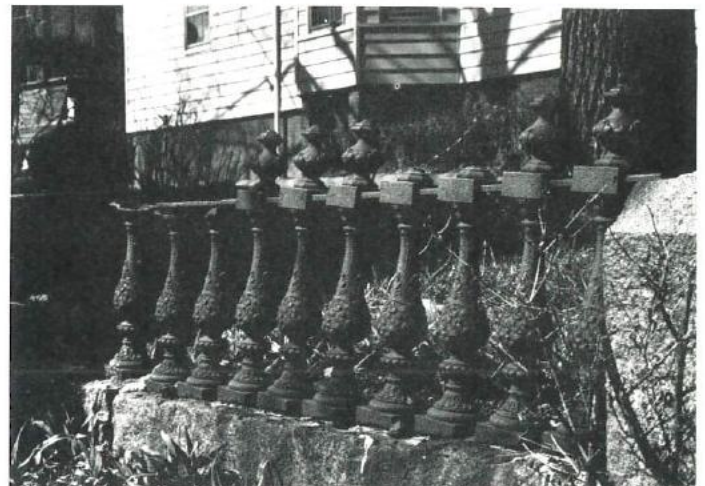



## Somerville's Industries

**J. P. SANBORN,  
FACE BRICK**

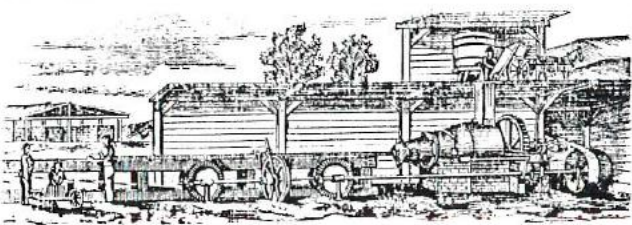

**MANUFACTURER,**  
**Mystic Avenue, - East Somerville, Mass.**

The best quality of Face Brick furnished to order, and warranted to give satisfaction.  
Orders by mail or express promptly attended to.

In the nineteenth century, Somerville's industries were allowed to expand across marshland and hillocks, eventually surrounding the shoreland at the north, east, and southeast. At the turn of the century, Somerville led Middlesex County in the production of processed meat and food products. With its other industries, the city employed thousands of residents, although most of the resident population was employed outside the city limits. The following descriptions indicate the variety of goods and services, as well as the ingenuity and entrepreneurial success, which characterized Somerville's industries.

With regard to the conflict between industry, open space, and residential development, however, it should be asked what these industries left to Somerville. Unlike the case in Cambridge and Lowell, also leaders in Middlesex County industry, the owners of Somerville's major factories and firms left few civic improvements, no monuments, and no tracts of land for parks or open space. Somerville's industrialists more often laid out speculative subdivisions and built moderately priced houses on the land that they controlled. This met the city's demand for housing, but perhaps indicates that the typical industry owner shared no grand vision for Somerville's future as a modern city.



### Early Somerville Industries

Through the seventeenth and eighteenth centuries, the inhabitants of Somerville were occupied primarily with farming. Quarrying, fishing and pottery-making also occupied a few. The construction of the Charlestown Bridge to Boston in 1796, linking the city with the towns to the north and west, was a key factor in the industrial development and occupational character of Charlestown, Somerville, and the dairying communities farther out—West Cambridge (Arlington) and Lexington. Land routes into Boston—hitherto limited to a long circuitous route through Watertown, Brookline and Roxbury—were greatly improved between 1796 and 1820, creating a market for daily produce deliveries from the north. Subsequently, Lexington and Arlington farmers, already supplying nearby communities, developed regular milk deliveries into Boston. By rising at 2 a.m., Lexington farmers and their wagons (passing over what is now Massachusetts and Somerville Avenues, through Union Square and Charlestown) could arrive in Boston by dawn. From this activity, Charlestown Lane, now Somerville Avenue, gained its early name of “Milk Row”. Other farm products also came through Somerville on their way to Boston or Charlestown docks. Between 1806 and 1837, Wilmington, for example, sent over 8,200 tons of hops through Somerville to Charlestown wharves, some to be loaded onto schooners or consumed by local breweries. Begin-

ning in the eighteenth century, the radiating roads and turnpikes that converged in Somerville made it the logical site for food processing industries.

**G. S. ROLLINS,**

MANUFACTURER OF



**CAKES**

AND

**CRACKERS,**

Garden, near Beacon Street.



**SOMERVILLE DYEING AND BLEACHING COMPANY.**  
*AGFRED ALLEN, Agent & Treasurer, No. 33 Milk Street, BOSTON*  
 Milk Row Bleachery and Dye Works, 1864.

### Milk Row, later Middlesex Bleachery and Dye Works

Milk Row also became the site of Somerville's earliest manufacturing industry, the Milk Row Bleachery and Dye Works constructed about 1820. Little is known of its earliest activities, but its location on the Miller's River would have provided a source of water as well as a natural outlet for the firm's waste liquids. The company dyed the cotton and woolen yarn brought to them, and bleached and pressed cotton and linen goods. By 1822 the firm's agents, including Duncan Wright of Charlestown and Andrew Allen of Boston, were advertising the plant as "steam powered," one of the earliest instances of steam's advertised use in the area. For the next half century, the company's products dominated the Somerville industrial statistics. As late as 1865, the annual value of its finished cloth was over \$1.3 million. Only the brass and copper tubes of the nearby American Tube Works came close to matching the annual product value of the firm. After several reorganizations, the Middlesex Bleachery and Dye Works, as the firm eventually became, continued its activities well into the twentieth century. Before it closed in 1936, it was said to be the oldest textile finishing plant in the U.S.<sup>1</sup> Allied textile industries, such as the Victoria Iron Works at 32 Kent St., established in 1889, were situated nearby in Ward II. The Victoria Iron Works were established by Albert and Arthur Birch and manufactured machinery for calico printers.

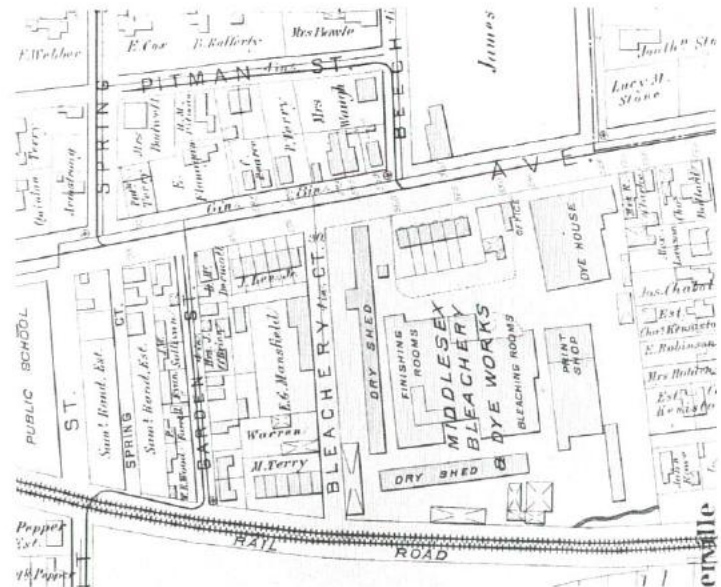



### Brick Manufacture In Somerville

The largest non-agricultural employer in town, and the industry which characterized the landscape for seventy years following the Revolution, was the brick-making business. The proximity of a major metropolitan area, coupled with the extensive glacial clay deposits of the Boston Basin, provided the impetus for early brick manufacture in the inland towns of Medford, Cambridge, and Somerville.<sup>2</sup>

Salem is widely believed to have been the location of the first brickyard operation in the English colonies, established by 1629. By 1636 bricks were being manufactured in "marshland near Boston," and a description of that town in 1657 reported that the use of brick was by then widespread.<sup>3</sup>

The first brickmaking in Medford was reported in 1647, and the town seems to have developed an early lead over other towns in this field. A building said to be the oldest brick house in New England was built for Peter Tufts in Medford about 1675. By the end of the seventeenth century, Medford had acquired at least three more brick houses. Although brick manufacture was introduced into Cambridge by 1660, for most of the eighteenth century, Medford appears to have dominated the industry, one writer noting several instances in which Medford brickmakers later went on to initiate the industry in other towns.<sup>4</sup> One of the early names associated with brickmaking in Medford was that of a Dr. Tufts who in 1761 bought land in the town called the "brickyard pasture."<sup>5</sup>

The earliest record discovered of brickyards in Somerville is a "Plan of the Middlesex Canal" surveyed in 1829 for Loammi Baldwin.<sup>6</sup> Marked, but otherwise unlabeled, are the locations of eight brick kilns adjacent to the Medford Turnpike (now Mystic Avenue), the Middlesex Canal, and Broadway.

By the middle of the nineteenth century, a number of large yards had been established in the Boston area. In addition to the 1832 yard in Cambridge already noted, a Boston yard in 1846 was producing 100,000 bricks per day (possibly 18 million yearly) with twenty machines.<sup>7</sup> The yard of Peter Hubbel of Charlestown, which manufactured 15-20 million bricks yearly, had thirty machines.<sup>8</sup>

Somerville's production at this time was still limited. Although the list of brick manufacturers identified by the 1850 Federal manufacturing census including brickmakers, (Mit-

**Brickyards at Ten Hills, 1883.** At right, long brick sheds line the clay pits.

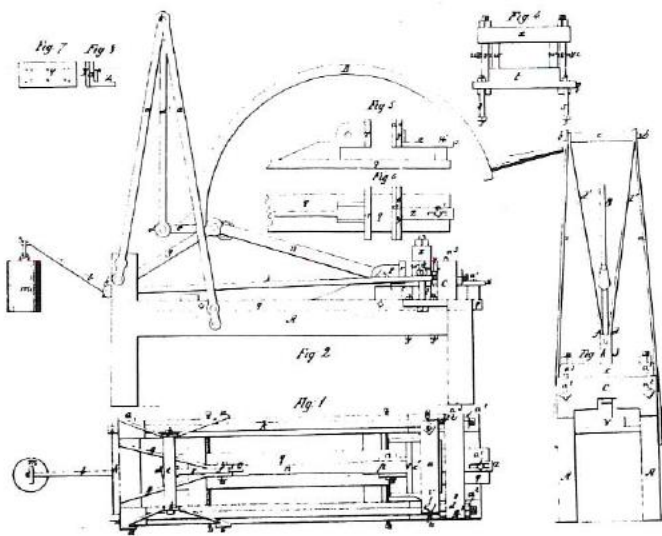

Wilson Brick Press, patented 1841.

chell, Fisk, Kinsley, and Wyatt) is probably incomplete, none employed steam engines or any of the new brick extruding or pressing machines then becoming available. Mark Fisk's yard, capitalized at \$3,000, was the largest, producing annually 10,000 bricks.<sup>9</sup>

These yards employed hand-moulding techniques in use since the seventeenth and eighteenth centuries. A good moulder could produce 2,000–2,500 bricks per day.<sup>10</sup> It was about this time that Somerville's Timothy Tufts developed a brick-making machine which he later used successfully for many years.<sup>11</sup> The earliest record of steam engines and brick making machinery introduced into Somerville was in 1853, and its existence was clearly an aberration. In that year, the Boston Press Brick Company was incorporated, with a capital of \$150,000. By 1855, the company was equipped with two steam engines and five patent presses, and their annual production amounted to 5.5 million bricks.<sup>12</sup>

In the decade between 1850 and 1869 the number of men employed in the various Somerville yards more than tripled and the quantity of brick quadrupled. Of the eight yards recorded in the 1860 manufacturing census, David Washburn's was the largest, capitalized at \$10,000. All the yards relied on horses to mix the clay, sand, and water, though the moulding process remained a hand operation.

The decade which followed witnessed a dramatic expansion with the appearance of both the Tufts Brick Manufacturing Company and the Massachusetts Brick Company, two heavily capitalized yards employing steam and elaborate brickmaking machines.

Three different machines came into use in Somerville yards during the 1860s. Most popular was the "Wilson Press," a hand-operated machine adopted by the smaller yards. The press was manufactured by a Malden man, Charles Heath. His 1869 trade advertisement lists forty two endorsements from brickmakers from Maine to Missouri; thirteen of them were from Somerville. The treasurer of the Massachusetts Brick Company in Boston wrote in his endorsement that the press was "in almost universal use with the brick-makers of New England." The Somerville yards which used the Wilson press employed from seven to sixteen men. Three people were required to work the press efficiently, the manufacturer wrote—a pressman to work the lever up and down, a boy to put the hakes in the press; and a boy to take them out. "Eight thousand is an average day's work for one man and two boys' under favorable circumstances, ten thousand have been pressed in a single day of ten hours."<sup>13</sup>

Joseph Sanborn, who at this time had a small yard on Mystic Avenue near Union Street, employed one Wilson press and seven men. His advertisement in the 1870–71 Somerville Street Directory, however, includes a woodcut of one of the modern extrusion machines in which a continuous bar of clay forced through a die was carried through a cutter to be cut into individual bricks.<sup>14</sup>

There is little information about the Chandler brick machine in use by the Massachusetts Brick Co., though the size of the yard and its operation by steam suggests a machine of some complexity.

Timothy Tufts' extensive Tufts Brick Manufacturing Company between Cedar and Willow streets used a brick machine of Tufts' own design, patented in 1867. Tufts' machine was typical of the earliest brickmaking machines, in which a set of molds was loaded and then filled automatically by the machine which also applied pressure and a knife to remove the excess clay. In the patent specifications, Tufts claimed that with his machine, "very perfect bricks can be made, so closely resembling what are termed 'pressed bricks' as to often render it difficult to distinguish any difference between them."<sup>15</sup> In 1870, he

had two of these machines in his yard. In that year, Tufts employed 140 men, and produced 10 million bricks a year, making his the largest yard in Somerville.

The year 1870 also saw the peak of recorded brick production both in Somerville and in the Middlesex County. The economic expansion of the post Civil War years is evident both in population growth and in the expansion of the brick industry, which by now numbered a dozen and produced over 24 million bricks a year. This period came to an end in the financial depression which began in 1873. Of the dozen firms in operation in 1870, four had closed by 1875, with three more following by 1879. By 1885 only two remained. Ten years later, only the Sanborn yard, now on Mystic Avenue opposite Wheatland Street survived and this yard closed by 1902.

Two other factors led to the disappearance of brickyards. One was the economies made possible by the new machinery, which forced out small yards which could not make large capital investments in land or equipment. Second, the rising value of land in Somerville, whose residential population was growing explosively, forced many of the larger brick companies to move to the less congested areas of Maine and New Hampshire.



Sanborn Brick, Columbus Avenue.

## Industries in the Town of Somerville: 1842–1872

The construction of the Middlesex Canal in 1803 through the clay lands of the western shore of the Mystic River encouraged the growth of brick yards. Thirty-two years later, the canal's arch-rival, the Boston & Lowell, became the first railroad to be constructed through Somerville, carving a route between Winter and Prospect Hills. Four years later, in 1839, the Charlestown Branch Railroad (in 1845 to become a part of the Fitchburg Railroad's main line) was built to link North Cambridge ice houses with the Charlestown docks. In subsequent years both rail lines determined the location of numerous Somerville industries. Pre-railroad era industries, however, were located along Washington Avenue, between Union Square and Charlestown, and along Somerville Avenue. There were a few exceptions, such as the Runey Pottery, which was built on Cross Street in East Somerville.

## Ropewalks

After the construction of the Middlesex Canal and new bridges, the movement of new industries into Somerville was led by the ropewalks. Ropemakers worked in Charlestown for nearly 200 years, but the long sheds required for spinning the line took up valuable land in an increasingly congested community. Hiram Allen (after whom Allen Street was named) was one of the first to set up a ropewalk in Somerville and was also one of the signers of the petition requesting the incorporation of the town of Somerville. His business was established near Union Square, shortly after the construction of the Charlestown Branch Railroad in 1839. By 1850, Allen employed five men and a horse to power the ropewalk machinery. The fourteen tons of cordage produced that year were valued at \$5,000. In the 1860s Allen's plant was removed, a victim of rising land values in the Union Square area.

James Galletly's twine works had a longer life. Born in Scotland in 1815, Galletly grew up as a maker of twine and small cordage. In 1840, at the age of 25, and by then one of the best hand linen spinners in Scotland (as his obituary claimed), he came to Somerville with his wife and three children to join his mother in a shop on Washington street near the present-day Holiday Inn.<sup>16</sup> There, three generations of the family worked to manufacture twine. At Galletly's death in 1895, the

shop, run by his son Henry, was said to be one of only two in the state where hand-spinning of twine was still done.

### Spike Works

Galletly's twine works on Washington Street was the first of a variety of industries to be established near Washington Street. The spike factory of Bartlett and Page was probably begun soon after the incorporation of the town. By 1850, it was the second largest industry in Somerville, producing annually over \$52,000 worth of railroad spikes and nails with a work force of sixteen men. Little is known of Bartlett and Page, but in 1864 the spike works was purchased by John Sylvester (1798-1882),<sup>17</sup> a prominent iron master from Hanover, Massachusetts. Sylvester & Co. operated the Somerville Spike Works into the twentieth century. Nearby the foundry of W.R. Bradford employed twenty five men in 1860 in producing different types of iron castings.

### Pumps, Glass, and Tubes

Another industry established in the town's first decade of independence was a wooden pump factory erected by Samuel Hamblin and Caleb Kingman about 1845 on Kingman Court. Kingman and Hamblin made the wooden pumps ("of the very best white oak and pine timber") used in the distilleries and tanneries of Charlestown, as well as in the brickyards of Somerville, Cambridge, and Medford.<sup>10</sup>

In 1851 the American Tube Works began construction of a plant to produce seamless brass and copper tubes, and three years later, the Union Glass Company erected its Union Square works on Webster Street.

### American Tube Works

The American Tube Works located on Somerville Avenue at Dane Street was incorporated in March of 1852 for the purpose of manufacturing seamless brass and copper tubes. The company had obtained exclusive right to manufacture "Green's Patent brass tubes," patented in England four years earlier. Freeborn Adams, a South Boston machinist, invented similar equipment to produce seamless copper tubes and was the first director of plant operations. American Tube produced seamless boiler tubes for locomotive, marine, and stationary engines as well as tubes and piping for a variety of other purposes. Holmes Hinkley, proprietor of the Hinkley Locomotive Works in Boston, was one of the original incorporators of the concern. The company appears to have been immediately successful. By 1865 it employed 175 men (second only to the Union Glass Works) and produced \$1.2 million worth of brass and copper tubing. In the first decades of the twentieth century, the company expanded and totally rebuilt the complex with four large drawing mills, rolling mill, foundry, and pattern and blacksmith shops, all arranged around three sides of the Milk Row Cemetery. The oldest building still standing is the ca. 1890 machine and pattern shop, located at the rear of the cemetery. Today, the seven brick buildings on Somerville Avenue which remain of the complex house separate firms.

**SOMERVILLE  
PUMP MANUFACTORY.**

The undersigned takes this opportunity to inform his friends and the public in general, that he continues to carry on the **PUMP BUSINESS** as usual at the old stand, located on **Washington Street**, a few rods west of Union Square, where he keeps on hand a

**LARGE STOCK OF WOODEN PUMPS,**  
made of the very best of **WHITE OAK** and **PINE TIMBER**, suitable for **Distill Houses, Tanneries and Brick Yards**, as well as all kinds of **Yard and House Pumps.**

**CALEB KINGMAN, Proprietor.**

Orders solicited and promptly attended to.    Wooden Pumps repaired at short notice.

**AMERICAN TUBE WORKS,**

SOLE MANUFACTURERS IN AMERICA

OF

GREEN'S AND ALSTON'S PATENT

**Seamless Drawn Brass Tubes**

AND

ADAMS' PATENT

**SEAMLESS DRAWN COPPER TUBES**

FOR

**Locomotive, Marine and Stationary Boilers,**  
Heater Tubes, Worms for Stills, Hand Rail, Pump Chambers, Feed Pipes, Scent Pipes, Paper Rolls, Bilge Pipes, Steam Pipes, Condensers, Pump Rams, Printer's Moulds, and other Purposes.

PARTICULAR ATTENTION IS CALLED TO THE USE OF OUR SEAMLESS DRAWN BRASS TUBES, FOR PLUMBING, IN PLACE OF LEAD AND OTHER PIPES.

## Union Glass Company

The Union Glass Works were founded in 1854 by Amory and Francis Houghton, and for nearly two decades, the Union Glass Company was the town's largest industrial employer. Though an offshoot of the larger New England Glass Company in East Cambridge, the plant remained in operation until 1924, long after all other Boston-area firms had closed or moved away. Like the New England Glass Company, the firm made only flint glass. Its products included tablewares, lamps, globes, and shades. Union Glass was the first in the U.S. to blow the large protective shades fashionable in the last quarter of the nineteenth century to protect statuary and other museum pieces. For the Chicago World's Fair in 1893 the firm produced what was said to be the largest piece of cut glass ever made—a 150-pound punchbowl. By the early twentieth century, however the high cost of fuel and raw materials made competition with the newer midwestern plants increasingly strained.



Union Glass Showroom, ca. 1890.



American Tube Works.

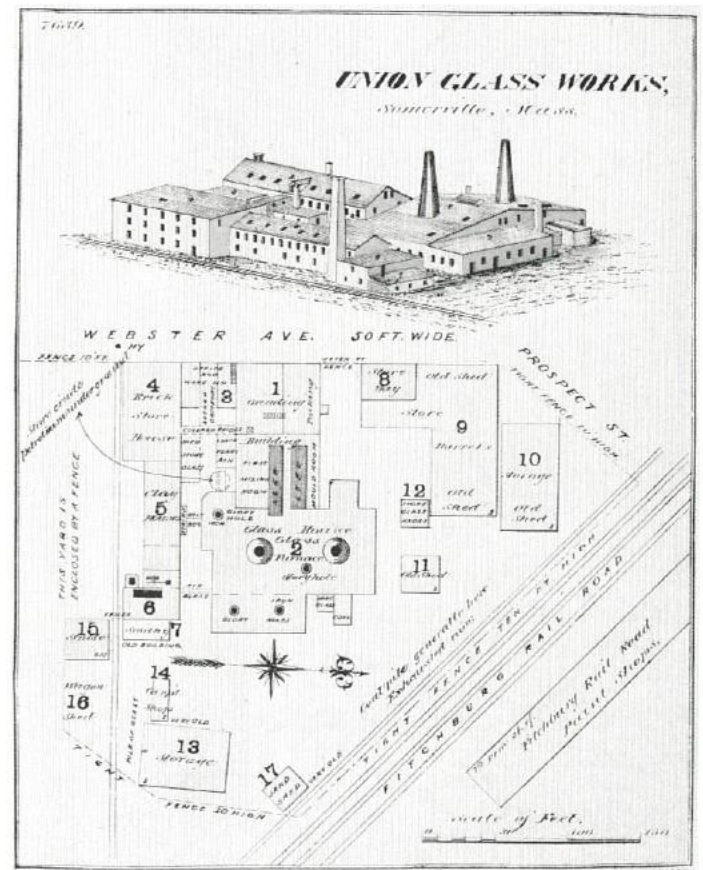

Union Glass Company.



## Food Processing

### Vinegar and Pickles

Several factors made Somerville a center for the manufacture of vinegar and pickles. An abundance of agricultural and livestock products, good rail access and proximity to Boston, led to the development of food processing plants, including distilleries, bakeries, meat packing plants, and vinegar works. From the towns to the north, the Boston & Lowell and the Fitchburg railroads brought carloads of vegetables and fruits to Charlestown's docks and Boston's consumers. Apples were a favorite crop and by the 1850s, a portion of the crop was processed in Charlestown as cider and vinegar. By 1855, Charlestown had two large pickle factories.

Amos Haynes was a pioneer in the large-scale manufacture of cider and vinegar in New England. He was born in Charlestown in 1823, where he built a successful vinegar factory. By the late 1850s, he moved to Washington Street in Somerville, erecting what eventually became the largest vinegar factory in New England.<sup>2</sup> Apples by the trainload came from farms all over New England and from New York. Within a decade of Haynes' opening in Somerville, a second vinegar factory had been opened across the street by Michael Durant. When Durant died about 1889, the plant was sold to Arthur Rowse, whose Standard Vinegar Co. outlived Haynes' enterprise.

Perhaps the most famous vegetable product to come out of Somerville was the "Bunker Hill Pickle." Manufacturer George Skilton entered into the vinegar business in Charlestown in 1850s. During the Civil War, the firm made a speciality of furnishing the Navy with pickles. After the war, in company with Edward Foote, the firm decided to concentrate solely in pickles and sauces, adopting the "Bunker Hill Brand" as a trademark. They erected a factory on Walnut Street in Somerville, which produced the well-known variety of pickles and sauces for over 40 years.<sup>21</sup>

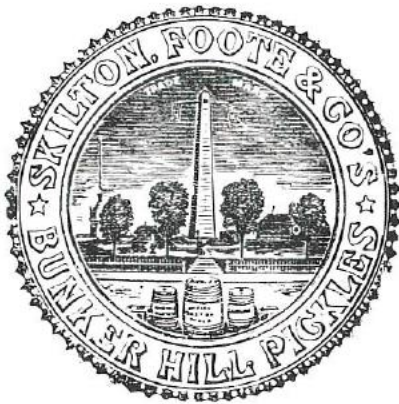

### Meat-Packing Plants

It was in the meat packing plants, however, that Somerville excelled. The growth of packing plants was made possible largely by the location of the Grand Junction Railroad in 1855 near the salt marshes and Cobble Hill. The Grand Junction was built to connect the railroads entering Boston from the north and west with its own depot and wharves at East Boston.

It brought the traffic of the Boston & Worcester (later Boston & Albany) Railroad to Somerville, from the livestock yards of Brighton as well as from New York and points further west. Eventually, the same line would also deliver the packed meat to ocean-going vessels at the East Boston docks.

By 1875, Somerville had three packing houses with a total annual product value of \$4.4 million, already more than the total value of all other manufactured products in Somerville. By 1898, with five packing houses, Somerville was said to be the third largest slaughtering city in the U.S.—the "Chicago of New England" as the city was called. As late as 1927, the leading industry—represented by four firms and 55 percent of the total value of manufactured products—was still the wholesale slaughtering of animals and packing of meat.

### Charles H. North Meat Packing Plant

Charles H. North's career in several respects paralleled that of his East Cambridge neighbor, John P. Squire. In 1842 John Squire, formerly a Vermont butcher, opened a stall in Boston's

North Packing Plant, ca. 1890.

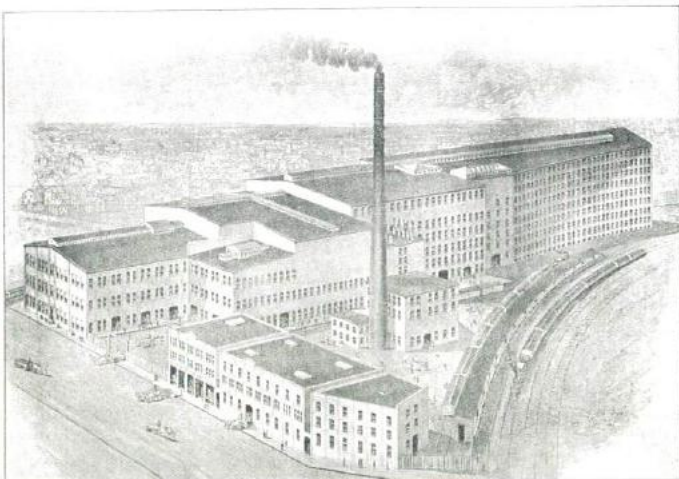

Faneuil Hall Market. Much of the meat product probably came from Brighton at this time, then the principal live-stock market of New England. With the completion of the Grand Junction Railroad in 1855, Squire erected a slaughtering plant in East Cambridge on the Somerville line. For a year, Squire continued to buy hogs from Brighton, but with the Grand Junction at his doorstep, Brighton was as accessible as western markets. In 1856 Squire began to purchase his stock directly from points further west. Squire maintained his stall in Faneuil Hall Market, and in 1862 he engaged another young butcher from Vermont, Charles H. North. North expanded his interests in the Market and in 1867 built a slaughterhouse in Somerville where the Grand Junction and Fitchburg railroads crossed directly across the city line from Squire's East Cambridge plant. From the start, North appears to have bought hogs directly from Chicago, where he sent one of his partners, L.E. Conant, as his buying agent.

In 1878 North's factory burned to the ground. In 1879, under the direction of architect T.B. Webster, an extensive new plant was constructed on twelve acres. The new facility employed 1000 men and could butcher 5000 hogs per day. Much of this plant has since been demolished, the buildings which housed the company's stables and wagon shop on Medford Street remain. A few yards to the north, on the opposite side of the Fitchburg Railroad tracts, the company constructed a four-story brick copper shop and box factory employing about 100 men. (This building burned in December 1981.) In 1913 the company built a fireproof smokehouse and pickling facility between older buildings.

Despite the introduction of the refrigerator railroad car in 1870s, New England markets long retained a distrust of western packing houses. Well into the twentieth century North and other firms continued to buy hogs from Chicago, Kansas City, Cincinnati, Indianapolis, Buffalo, and other western points. In addition to their local retail and wholesale trade (which in 1910 amounted to about 40 percent of the business), large quantities of bacon and pork were also exported to Europe, as well as Central and South America and the West Indies.

### Soap Making

The rendering of tallow and production of soap was a natural offshoot of the huge meat-packing business in Somerville. One block from the Charles North packing houses was the George W. Norton Soap Works, established in 1820 by Henry Norton. In 1887 George W. Norton became sole proprietor and the business was moved to South Street, to a plant subsequently destroyed by fire. The present plant, constructed in 1903 between Ward, Horace, and South streets, was considered "one of the most modern and best equipped soap and rendering plants in New England." Adjoining the three-story brick factory were engine room, stables, and storage sheds. The company manufactured laundry soap and a specialty, "Norton's Tidy Soap"—"one of the purest and best laundry soaps made"—according to their advertisements. In 1928 the building was still occupied by the Norton Tallow Company, with office space and shipping on the first floor, rendering tanks at the south end of the second floor, and storage on the third.

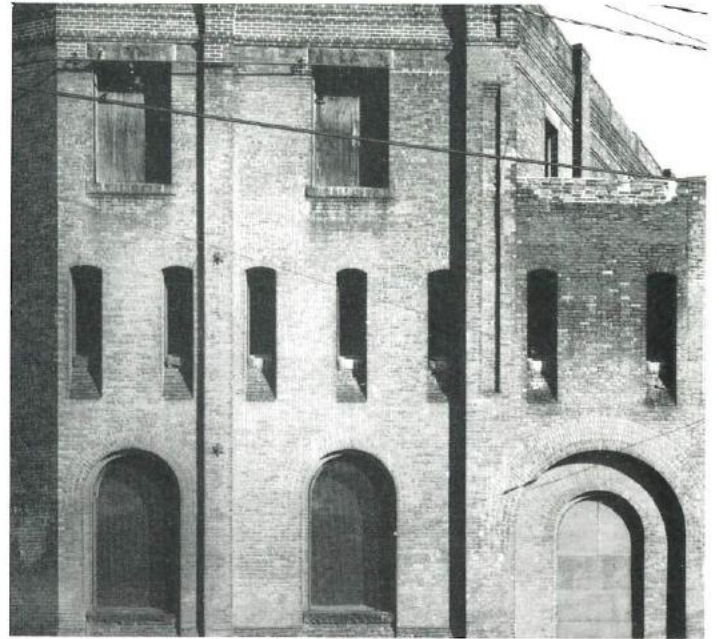

North Packing Plant, Medford Street.

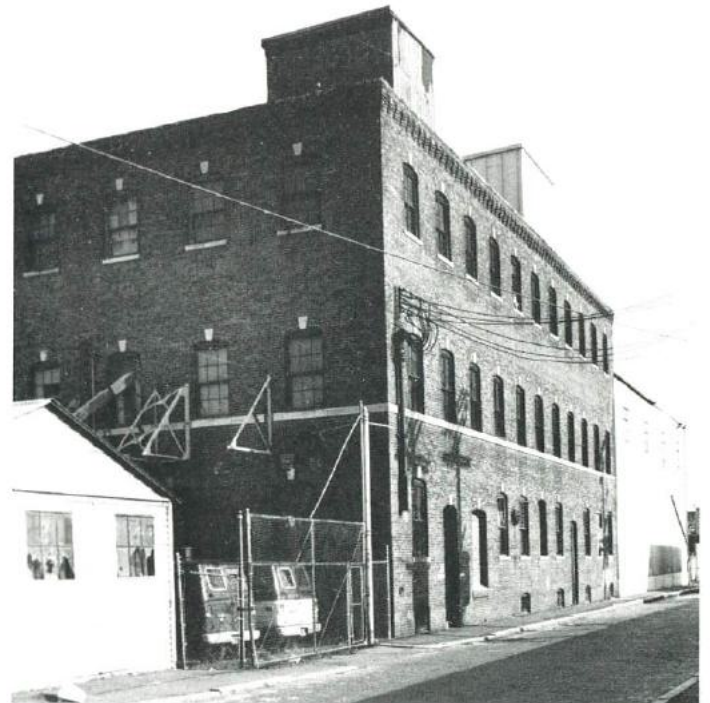

Norton Soap Works.

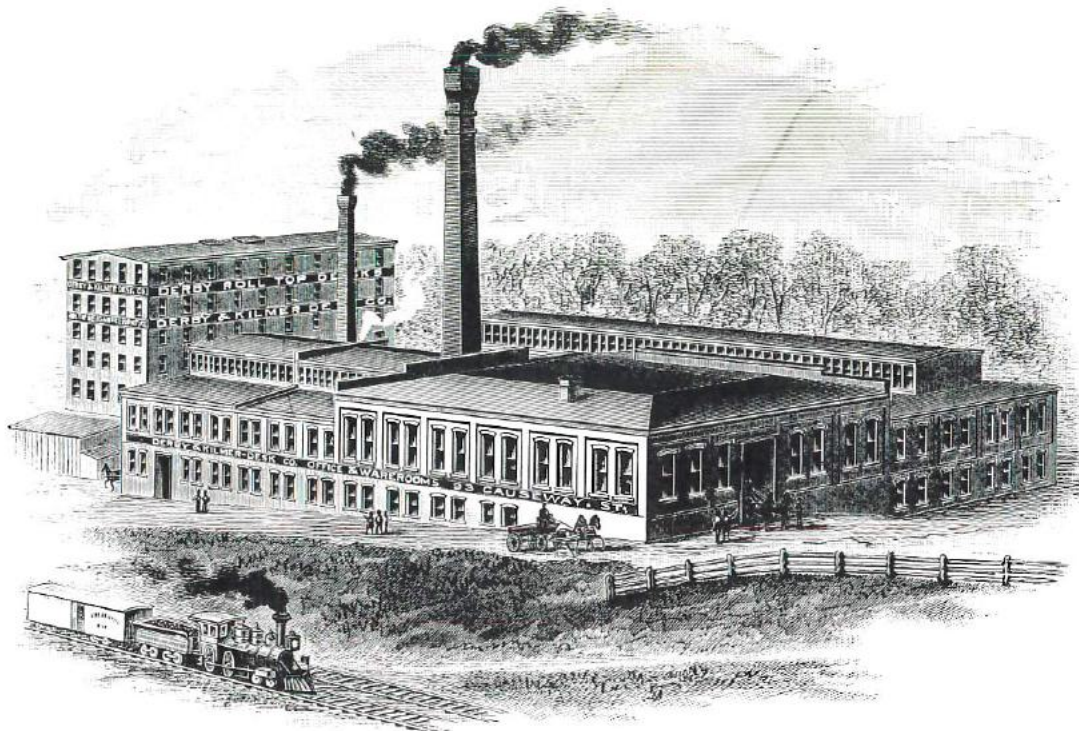

GEO. H. DERBY, *President.*

Factory of the DERBY & KILMER DESK CO.

FREDERICK M. KILMER, *Treasurer.*

### Industries in the City of Somerville: 1872–1900

One of the results of the city's phenomenal growth was a strong building industry, with half of all Somerville's residential construction taking place in the decade between 1890–1900. In the late nineteenth and early twentieth centuries, the city directories evidenced a variety of carpenters, builders, and lumber yards; woodworking shops included coffin makers, manufacturers of picture frames, office furniture, museum cases, tables, and the like. Related products included architectural hardware, brass foundries, tinware works, and makers of window shades. Many of these firms began in Boston, relocating in Somerville in the 1880s and 1890s.

### Derby Desk Co.

The Derby Desk Company was the most prominent of the many Somerville firms that manufactured moldings, coffins, furniture, and custom woodwork during the expansive years of Somerville's late nineteenth century growth. George H. Derby, born in 1847, learned cabinet making in a furniture factory in Leominster, and moved to Boston by 1872 where he established the Derby Desk Co. The specialty of the company was roll top desks. The successful firm sought larger quarters, and in 1882 the business moved to Somerville, where a five-story frame factory (burned 1968) was erected at 20 Vernon Street on the site of an old slate quarry adjacent to the Boston & Maine Railroad. Five years later, the two-story brick core of the present factory was built nearby. The remaining seven-story portion was built in 1895–97. At its height of production, with sales outlets throughout the country, Somerville's Board of Trade called the firm "the largest manufacturing industry in the world devoted exclusively to the manufacture of office furniture." In 1931 the company was sold to the Heywood Wakefield Furniture Company. By the 1950s, the building was occupied by several small tenants, most of whom had abandoned the building by 1960. In 1973 the Rogers Foam Corporation bought the building, leased the upper three floors to artists,

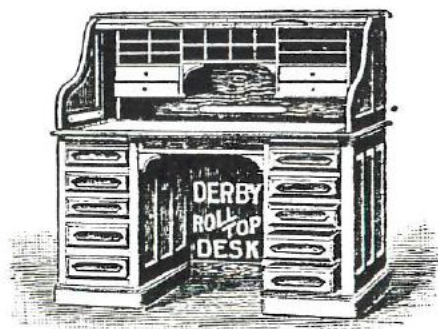

and subsequently renovated the first and second floors for their own use.

### C.W. Lyman & Co.

C.W. Lyman & Co., manufacturers of common and pillar extension tables, was established about 1888 by a Somerville lumber merchant, Paulinus F. Williams, and businessman Charles W. Lyman. Little is known about the company, but its successor, by 1894, was the Williams Table and Lumber Co., whose advertised products included "cabinet beds" and the "Butterfield" mantel. The manufacturing process was arranged so that the cleanest area for finishing and varnishing was on the top floor of the three-story wooden building, with cabinet work on the first and second floors, and sawing and planing in the basement. Attached to the main building were one and two-story lumber sheds, a dry house, and a brick boiler house. The firm appears to have survived only until about 1900. Today the building, at 356 Mystic Street, is used by a mop and brush manufacturer.

### I.H. Brown Moulding Co.

Another woodworking firm prominent in the boom years of Somerville's residential development was the I.H. Brown Moulding Company. When their planing and molding mill in Cambridge was destroyed by fire in 1886, the firm moved to 285 Washington Street, along the tracks of the Fitchburg Railroad near Union Square. The company specialized in mouldings of all descriptions, in addition to window frames, sashes, drawer cases, etc. The firm made museum cabinets for Harvard's Agassiz Museum, a product they subsequently produced for museums all over the country. In 1904 the company was succeeded by the Davenport-Brown Company, with a plant described as "one of the largest and best equipped in the state." Cabinetwork was carried out on the second floor of the two-story brick plant, while the first floor was used for sawing and planing.

### Miller Brothers Coffin Factory

This two and one half story wood-frame factory was built in 1881 at 309 Beacon Street at Miller Street by two brothers, Ellis F. Miller of Cambridge and Henry C. Miller of Winchester, for the manufacture of coffins, a use it retained until about 1903. For much of the 20th century it served as a door and sash warehouse. The building, which has a distinctive mansard roof with dormers, is composed of two sections, each approximately 115 feet in length, connected by a brick hyphen. The west section retains its original clapboarding. The building was originally provided with a spur tract from the adjacent Fitchburg Railroad, giving it a ready supply of lumber.



Derby Desk Factory, Vernon Street.



Miller Brothers Coffin Factory. Razed 1981.



Peter Forg Manufacturing Company.

### Peter Forg Manufacturing Company

Peter Forg, a German immigrant, began a woodworking shop in Somerville about 1881. When the building was destroyed by fire three years later, he turned to making brass cabinet latches. During the bicycle craze of the 1890s, Forg put much of his production into the manufacture of bicycle sprockets and other parts, and the oldest, two-story part of the existing brick factory at 50 Park Street dates to this expansive period (1902). Soon afterwards, with the collapse of the bicycle business, Forg began producing boilers and other parts for the Stanley Steamer, designing and patenting flash units for the automobile firm. Forg continued to produce builders' hardware including an adjustable electric fixture. In the 1930s and 1940s the company also made vending machines for the National Biscuit Company. Since World War II, Forg has performed metal stamping, drawing, and forming on a job-shop or custom fabrication basis. Today, the president of the company is the great grandson of the founder.

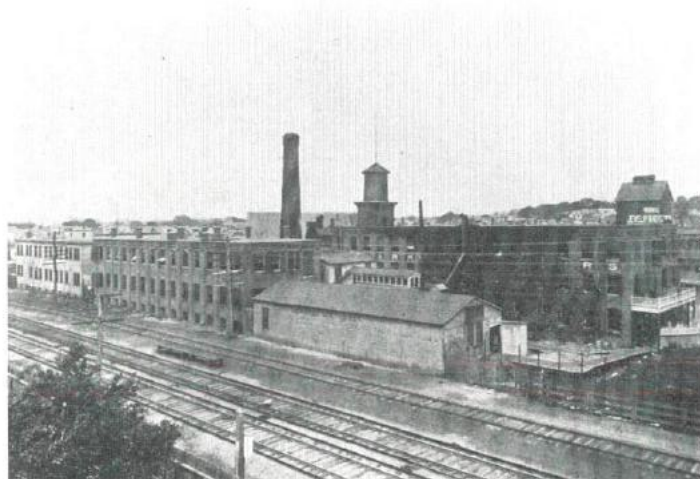

M. W. Carr and Company, 1916.

### M.W. Carr Company

Martin W. Carr (1829–1902) was born in Easton Massachusetts, where he began his career manufacturing shovels with the Ames Company. Later, he moved to Attleboro, where he went into business producing jewelry, a product line that has characterized that Bristol County city since the 1830s. Between 1861 and 1864 Carr served as foreman of the U.S. Armory at Springfield. At the end of the war he settled in Somerville, reentering the jewelry business with a factory in Boston. The firm moved to Somerville in the 1880s, and the present three-story brick factory at Gorham and Howard Steets was constructed in 1894. In subsequent decades the business continued to expand. By the early 20th century, with offices nationwide as well as in London, the firm was the largest plant of its kind, manufacturing novelties and fancy metal goods, including pewter and silverware, photo frames, and gift merchandise. The company remains in operation today, though its products are limited to a wide variety of wood and metal picture frames.



Sprague and Hathaway.

### Sprague & Hathaway

Sprague and Hathaway, established in 1874 in Boston by J.F. Hathaway and W.D. Sprague, did a thriving business in studio portraits—in oil, ink, crayon, water color, and pastel, as well as “solar and bromide prints by the sun or electric light.” As copyists, they made a speciality of producing portraits from small pictures. The construction of picture frames was begun in 1884, and in time what was initially a side line became the dominant business. In 1890, when the firm was formally incorporated, their 1887 Studio Building at Davis Square was, they claimed, “the largest portrait studio in the world.” In 1891 the firm erected the present four-story brick and granite “Studio Annex” at 58 Day Street, immediately behind the Studio Building. In 1915 the firm sent a large and varied exhibit to the Panama-Pacific Exposition in San Francisco, claiming a Grand Prize and considerable popular favor. The building has recently been rehabilitated for use as office space for a variety of tenants.



### Fresh Pond Ice Company Distribution Plant

The Fresh Pond Ice Company was an outgrowth of the business established by Jacob Hittinger at Fresh Pond, a glacial kettle hole in northwest Cambridge that had been the site of some of Frederic Tudor's earliest commercial ice harvests in the 1820s. From their Charlestown docks, Gage, Hittinger & Co. were among the first shippers of ice to Calcutta and the West Indies. Enjoying immense trade in the 1840s as the ice trade was transferred to other ports, Hittinger's business became primarily local. The Fresh Pond Ice Company, with Hittinger's son Thomas as superintendent, was organized in Cambridge in 1882. When the City of Cambridge took over Fresh Pond for its water supply in 1891, the company found a new source of ice in Lake Potanipo, Brookline, New Hampshire. In 1892, retaining their retail trade in Somerville and Cambridge, they constructed "the finest, most complete ice distributing plant in New England" at 321 Washington Street near the Fitchburg Railroad tracks. Facilities included a 600-foot long ice storage and loading shed built along the railroad tracks and a still-extant wood-frame stable and office. In addition to their retail trade, the company also supplied car-load lots to dealers in other cities and towns along the railroad. A repair shop was added in 1922.



Fresh Pond Ice Company.

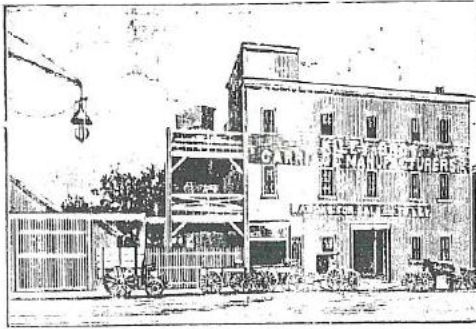

**J. A. KILEY**  
 Manufacturer of  
**CARRIAGES**  
 and **WAGONS**

Grocers', Express, Provision  
 Wagons and Caravans built  
 to order, and constantly on  
 hand. Repairing of all kinds  
 attended to. All work war-  
 ranted.  
 Somerville Avenue  
 Linwood and Fitchburg Sts.  
 SOMERVILLE, MASS.  
 Telephone 344 4

**James A. Kiley Wagon Shop**

James A. Kiley, wagon builder, moved to Somerville about 1890 and in 1896 established a shop at the corner of Linwood and Fitchburg streets. In 1900 the buildings consisted of the existing three-story frame wagon shop, a single-story wagon shed, and a small gable-roofed frame dwelling, predating the plant but long since enveloped by it. The Somerville Board of Trade, of which he was a member, described Kiley as "an expert in his line. . . . the repairing and painting department is unexcelled. . . . Kiley wagons have an excellent reputation for perfect workmanship, durability, and superior finish, and he also builds all kinds of bodies for automobiles." In succeeding decades the firm retained its prominence both in auto painting and in the construction of auto bodies. In 1932 the **Somerville Journal** noted that the company had "one of the finest and most modern paintshops in the country." The Kiley Company became one of the leading firms in the design and manufacture of telephone and power company truck bodies, still a product line today.



**Kiley Wagon Shop.**

## Somerville's Industries: 1900–1930

"Few cities of the East," Orra Stone wrote in 1930, "have had a greater industrial growth [than Somerville] during the first quarter of the twentieth century." The leading industry—represented by four firms and 55 percent of the total 1927 product value—was still the wholesale slaughtering of animals and packing of meat. Milk also remained an important product. Large dealers would gather milk in more northern towns of Massachusetts, Vermont, and New Hampshire, shipping it by rail to milk stations in Charlestown and Somerville. The Boston & Maine Station in East Somerville was said to handle 90 percent of all the milk and cream used in greater Boston. Other facilities were established for the distribution of New Hampshire ice, and, in the 1920s grocery warehousing plants for both A and P and First National Stores.

### Ford Motor Company/First National Stores Plant

The Ford Motor Company opened its first Boston-area assembly plant in Cambridge in 1914. In 1926 the company moved to Somerville, constructing a model assembly plant on filled land near the Mystic River (near the reputed location of the 1636 launching of Governor Winthrop's ship "Blessing of the Bay"). The original factory, with 340,000 square feet, was capable of turning out 400 cars every eight hours. The Ford Motor Company building, wrote Orra Stone, "embodies the latest idea in one-story structures, and was designed distinctly for the purpose of combining industrial economies and healthful working conditions." In 1937 the main assembly building was enlarged. Engaged in military contracts between 1942 and 1945, the plant resumed civilian automobile production in October 1945. In 1957 the plant was used for the assembly of the company's new line of Edsels, producing 11,354 cars before stock was exhausted. The following year, citing a ten-year program to consolidate operations in larger plants, the Ford Motor Company closed the Somerville plant. (In 1980 the complex, together with the adjoining First National Stores headquarters, was rehabilitated as the Assembly Square shopping mall.)

The First National Stores plant complex designed by Monks and Johnson of Boston in 1927, was constructed at the same time as the Ford Motor Company. Today the central office and garage (part of Assembly Square Mall) is all that remains of the original complex which included packing and bakery plants and warehouses.

Although Somerville—the Chicago of New England—was noted as a center of the meat packing industry, the 1920–1923 A and P grocery warehouse and bakery at 3–25 Fitchburg Street was noted as one of the country's first modern food distribution centers.



Ford Motor Company—Assembly Square.