

SITE PLAN
1/16" = 1'-0"



REVISED SITE PLAN

9-11 ALDERSEY STREET SOMERVILLE, MA 02143

NOV 6, 2020

KENNETH L. POOLE, AIA ARCHITECT
2 TEMPLE STREET MILFORD MA 01757

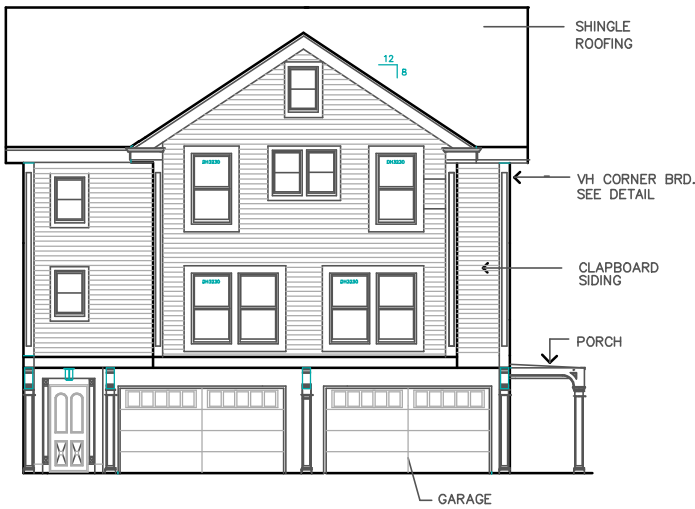

REAR ELEVATION – (NORTH)



LEFT ELEVATION – (WEST)

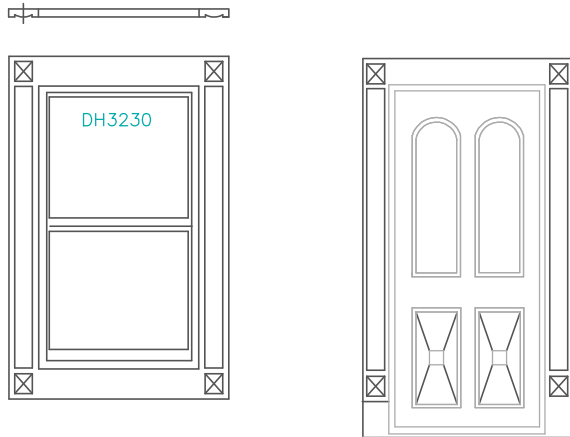

WINDOW-DOOR FRAME



BLDG A

FP: 2416 SF

9-11 ALDERSEY STREET
SOMERVILLE, MA 02143

NOV 6, 2020

KENNETH L. POOLE, AIA ARCHITECT
2 TEMPLE STREET MILFORD MA 01757



RIGHT ELEVATION – (EAST)

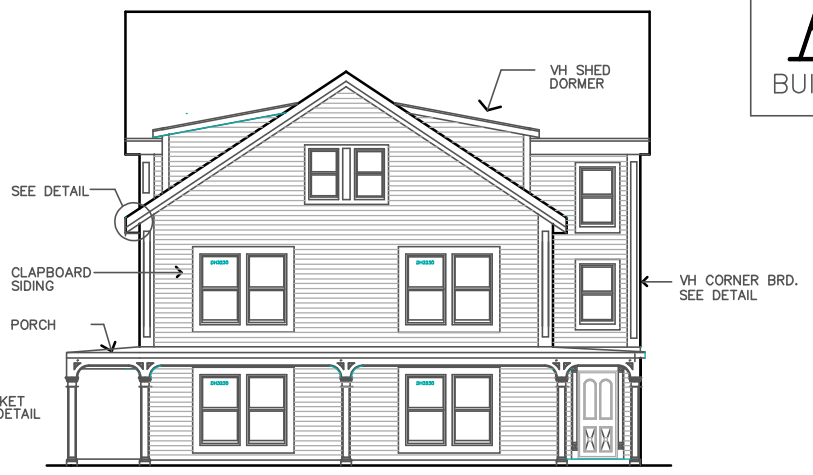

FRONT ELEVATION – (SOUTH)



WINDOW-DOOR FRAME

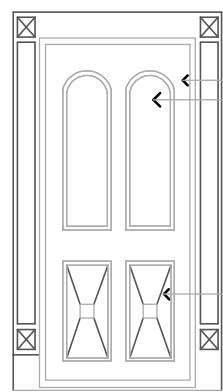

WOOD DOOR
GLASS LITES

WOOD PANEL

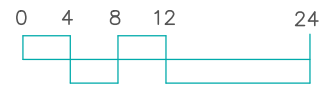

BLDG A
FP: 2416 SF

9-11 ALDERSEY STREET
SOMERVILLE, MA 02143

NOV 6, 2020

KENNETH L. POOLE, AIA ARCHITECT
2 TEMPLE STREET MILFORD MA 01757



LEFT ELEVATION – (WEST)

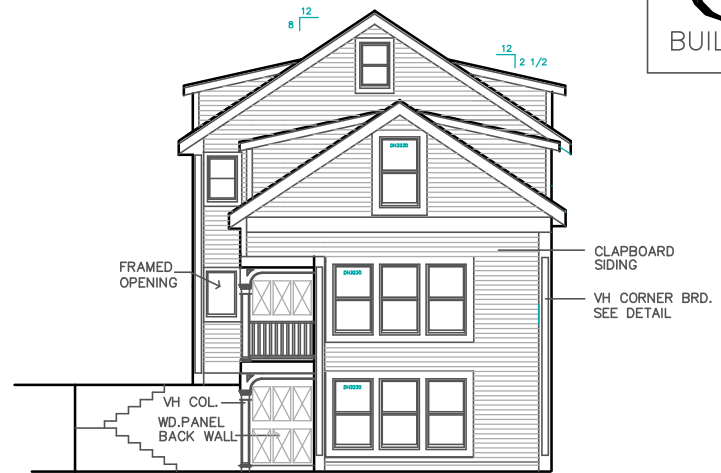

FRONT ELEVATION – (SOUTH)

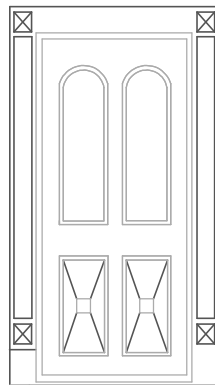
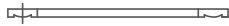

WINDOW-DOOR FRAME



BLDG C

FP: 2006 SF

9-11 ALDERSEY STREET
SOMERVILLE, MA 02143

NOV 6, 2020

KENNETH L. POOLE, AIA ARCHITECT
2 TEMPLE STREET MILFORD MA 01757

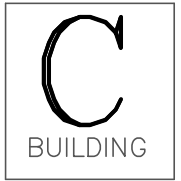

RIGHT ELEVATION – (EAST)

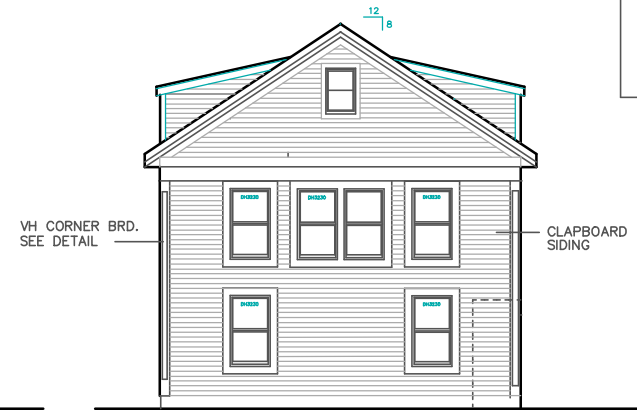

REAR ELEVATION – (NORTH)



WINDOW-DOOR FRAME

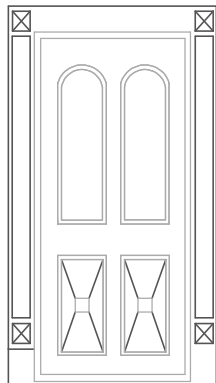

BLDG C

FP: 2006 SF

9-11 ALDERSEY STREET
SOMERVILLE, MA 02143

NOV 6, 2020

KENNETH L. POOLE, AIA ARCHITECT

2 TEMPLE STREET MILFORD MA 01757

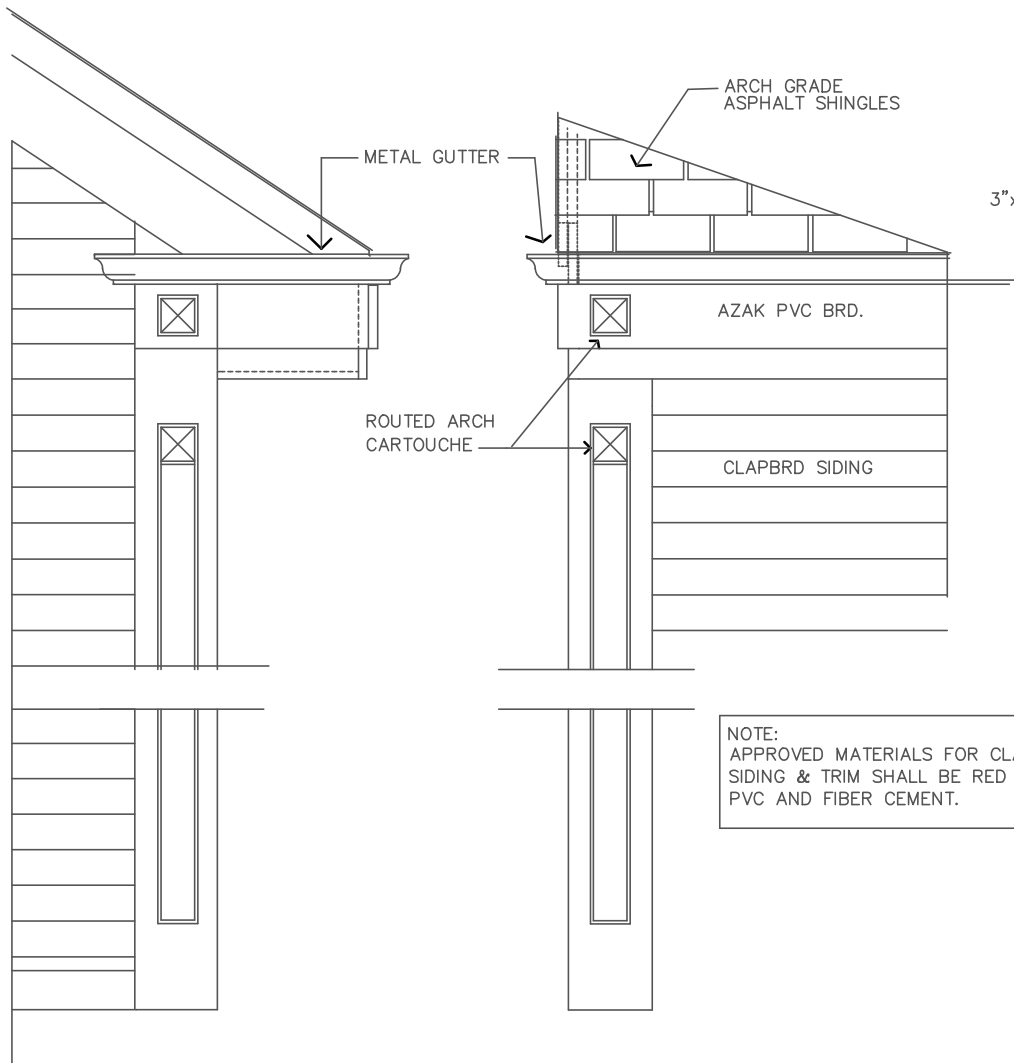

CORNER DETAIL

CORNER DETAIL

NOTE:
APPROVED MATERIALS FOR CLAPBOARD
SIDING & TRIM SHALL BE RED CEDAR,
PVC AND FIBER CEMENT.

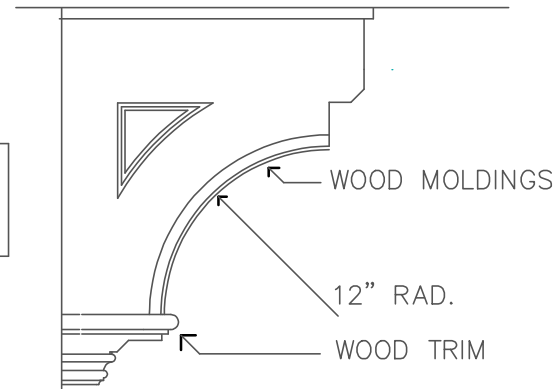
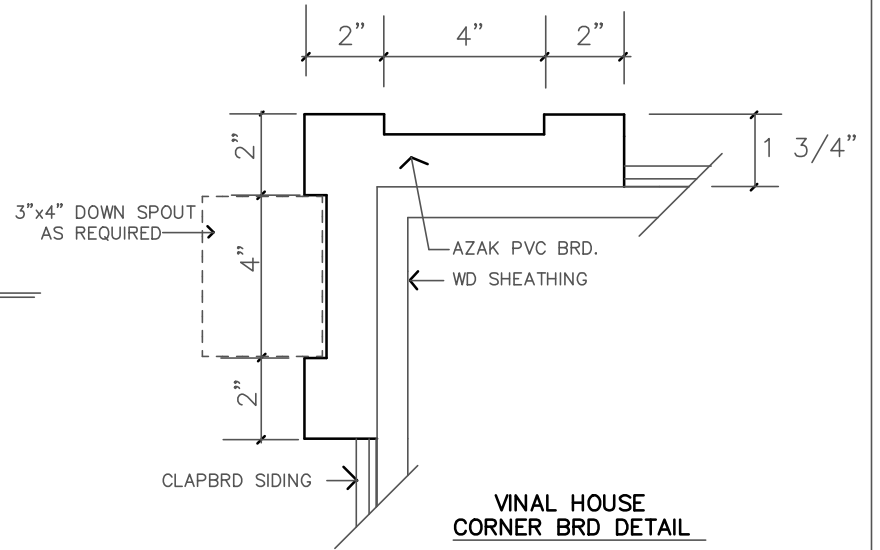

ITALIANATE BRACKET

DETAILS

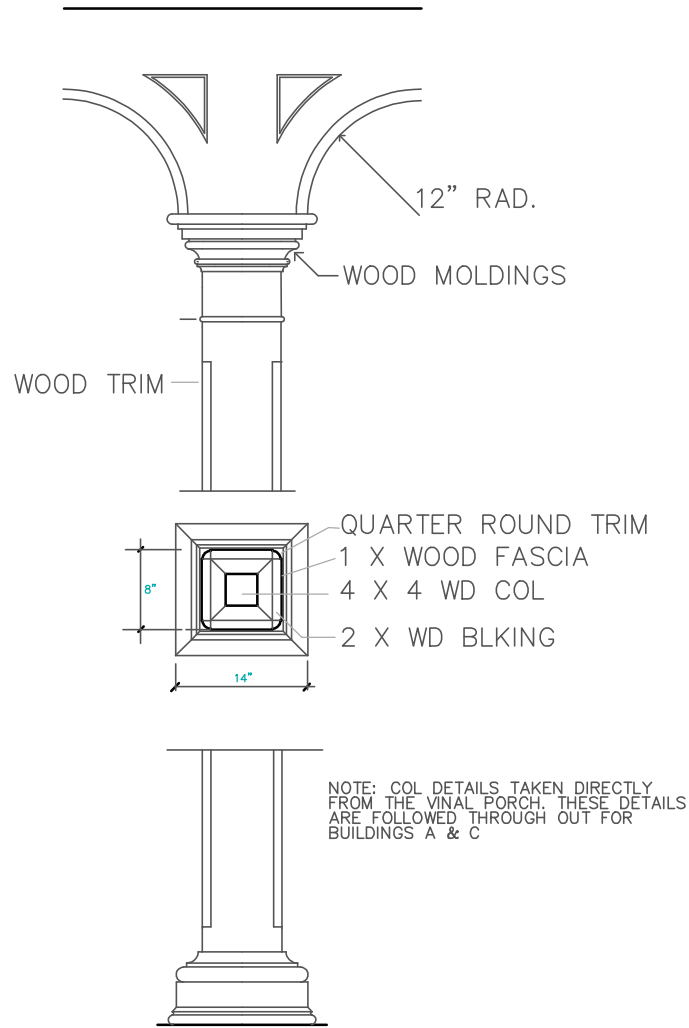

VINAL HOUSE PORCH
ITALIANATE COLUMN

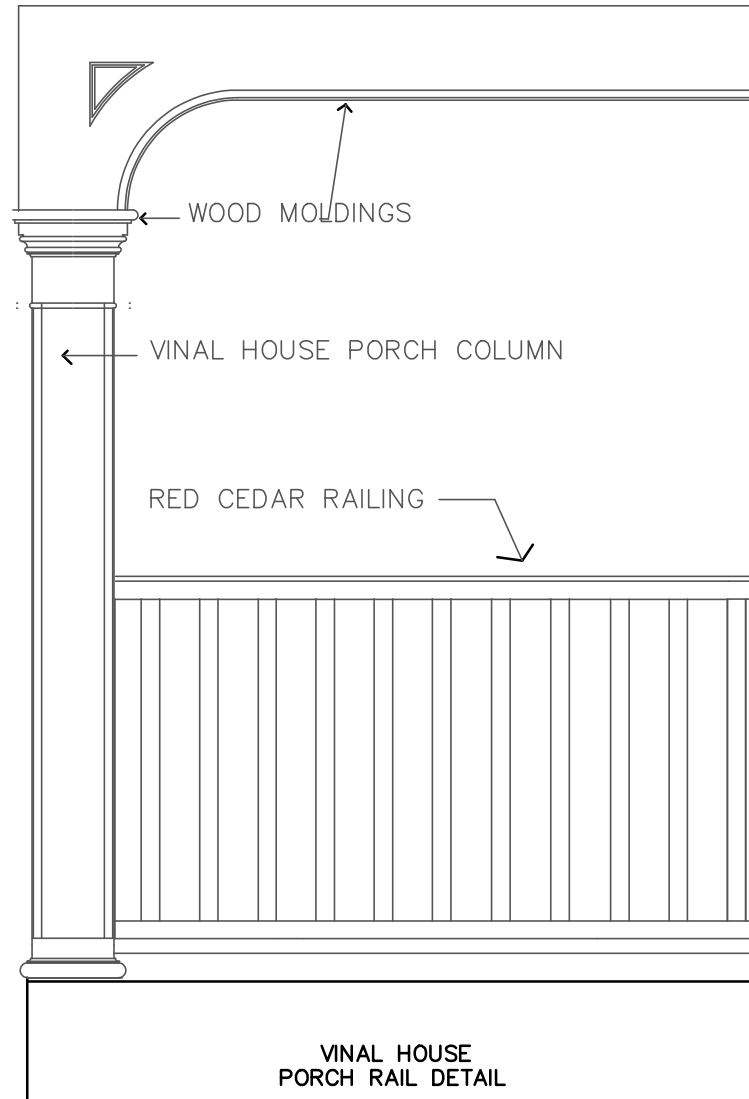

DETAILS

NOTE:
APPROVED MATERIALS FOR CLAPBOARD
SIDING & TRIM SHALL BE RED CEDAR,
PVC AND FIBER CEMENT.